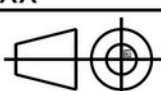

DESIGNED BY:
 DATE:
 CHECKED BY: XXX
 DATE: XXX
 SIZE
A4 
 SCALE **1:1** WEIGHT (kg) **XXX**

ADC007

DRAWING NUMBER **XXX** SHEET **1/1**

I	-
H	-
G	-
F	-
E	-
D	-
C	-
B	-
A	-

Ce dessin est notre propriété; il ne peut être reproduit ou communiqué sans notre accord écrit.